

DECO BASE-BOARD

Hochwertige Aluminium und Edelstahl Sockelleisten
mit formschönem Design und in edler Optik

High Quality Aluminium and stainless steel Skirtings
with beautiful design and in a precious appearance

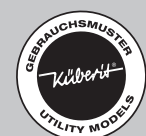



Aluminium eloxiert / aluminium anodized



F2
edelstahloptik
stainless steel optic



F2G
edelstahloptik fein geschliffen
stainless steel optic fine grinded



F3
poliert
polished



F4
silber
silver



F5
gold

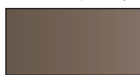

F6
bronze

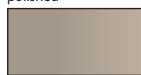

F9
sand

Edelstahl / stainless steel



F8G
Edelstahl matt gebürst
stainless steel matt brushed

INHALTSVERZEICHNIS

INDEX

		938 938 D 935	Aluminium System-Sockelleisten · eckiges Design Aluminium skirting system · angular strapped	4-5
		936	Aluminium System-Sockelleiste · mit LED Leiste Aluminium skirting system · with LED rail	6-7
		950 950 D	Aluminium System-Sockelleiste »Decostar« · mit Einschub Aluminium skirting system »Decostar« · with insertion slot	8-9
		934 934 D	Aluminium System-Sockelleiste · abgeschrägtes Design Aluminium skirting system · bevelled edge	10-11
		930	Aluminium System-Sockelleiste · abgerundetes Design Aluminium skirting system · rounded edge	12
		945 U	Aluminium Sockelleiste »Decolino« · mit Einschub Aluminium skirtings »Decolino« · with insertion slot	13
		910 911 912 913	Aluminium Sockelleiste · flaches Design Aluminium skirtings · flat design	14-15
		915 916	Matt gebürstete Edelstahl Sockelleiste · flaches Design mat brushed stainless steel skirtings · flat design	16
		369 369 N/SK 901	Aluminium Sockelleiste · Abschlussprofile Aluminium skirtings · Border profiles	16-17
		920 U	Aluminium Sockelleiste · geschwungenes Design Aluminium skirtings · curved design	17
		ZT	Messing Türstopper · mit patentiertem Dübelsystem brass door stopper · with patented dowel system	18
		ZR	Aluminium Heizrohrrosette · flaches Design Aluminium pipe ferrules · flat design	19

EINFACHE VERLEGUNG FÜR ALLE SYSTEM-SOCKELLEISTEN

EASY INSTALLATION FOR ALL SYSTEM SKIRTINGS



Wandhalter auf Boden aufsetzen, verschrauben und **Sockelleiste** aufclippen, dann **Endstück** anbringen. (Es wird keine zusätzliche Bohrschablone benötigt!)

Set **wall holder** on the floor, screw and clip on the **Base-Board**. Then put on the **end cap**. (No additional drilling template needed!)



Die **Eckstücke** mit der **Sockelleiste** verbinden und dann auf den **Wandhalter** aufclippen.

Connect the **corners** with the **Base-Board** and then clip it on the **wall holder**.



Sockelleiste mit **Eckstück** verbinden ① und dann auf den **Wandhalter** aufclippen ②.

Connect **Base-Board** with the corner ① and then clip it on the **wall holder** ②.



Verbindungsstück anbringen ③ und dann **Sockelleiste** mit **Endstück** aufclippen ④.

Put on the **connector** ③ and then clip on the **Base-Board** with the **end cap** ④.



Fertig!

Finished!

Prinzipiell ist die Verlegung bei allen Systemen identisch.

Basically the fastening of all systems is identical.

ALUMINIUM SYSTEM-SOCKELLEISTEN · ECKIGES DESIGN

ALUMINIUM SKIRTING SYSTEM · ANGULAR STRAPED



© Küberit®



Version mit grauer Dichtlippe!
Version with grey sealing lip!

938

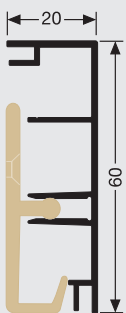

938 D

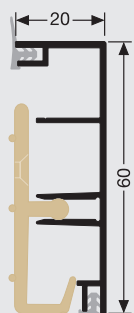

mit 2 Dichtlippen in grau
with 2 sealing lips in grey

935

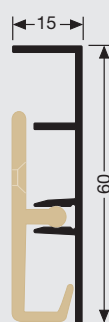

Lieferbare Länge:
available length:
2,5 m

Schrumpfverpackt, mit 7
Wandhaltern, Schrauben & Dübeln
shrink packed, with 7 wall
holders, screws and dowels

Lieferbar in Aluminium eloxiert silber
und edelstahl-optik mit fein geschliffener
Oberfläche.

Available in aluminium anodized silver
and stainless steel optic with sensitive
grinded surface.

ENDSTÜCKE, ECKEN UND VERBINDER · END CAPS, CORNERS AND CONNECTOR



Endstück, links
end cap, left



Endstück, rechts
end cap, right



90° Außenecke
90° external corner



90° Innenecke
90° internal corner



135° Außenecke*
135° external corner*



135° Innenecke*
135° internal corner*



Verbinder
connector

* nur für / only for 935

ALUMINIUM SYSTEM-SOCKELLEISTE · MIT LED LEISTE

ALUMINIUM SKIRTING SYSTEM · WITH LED RAIL

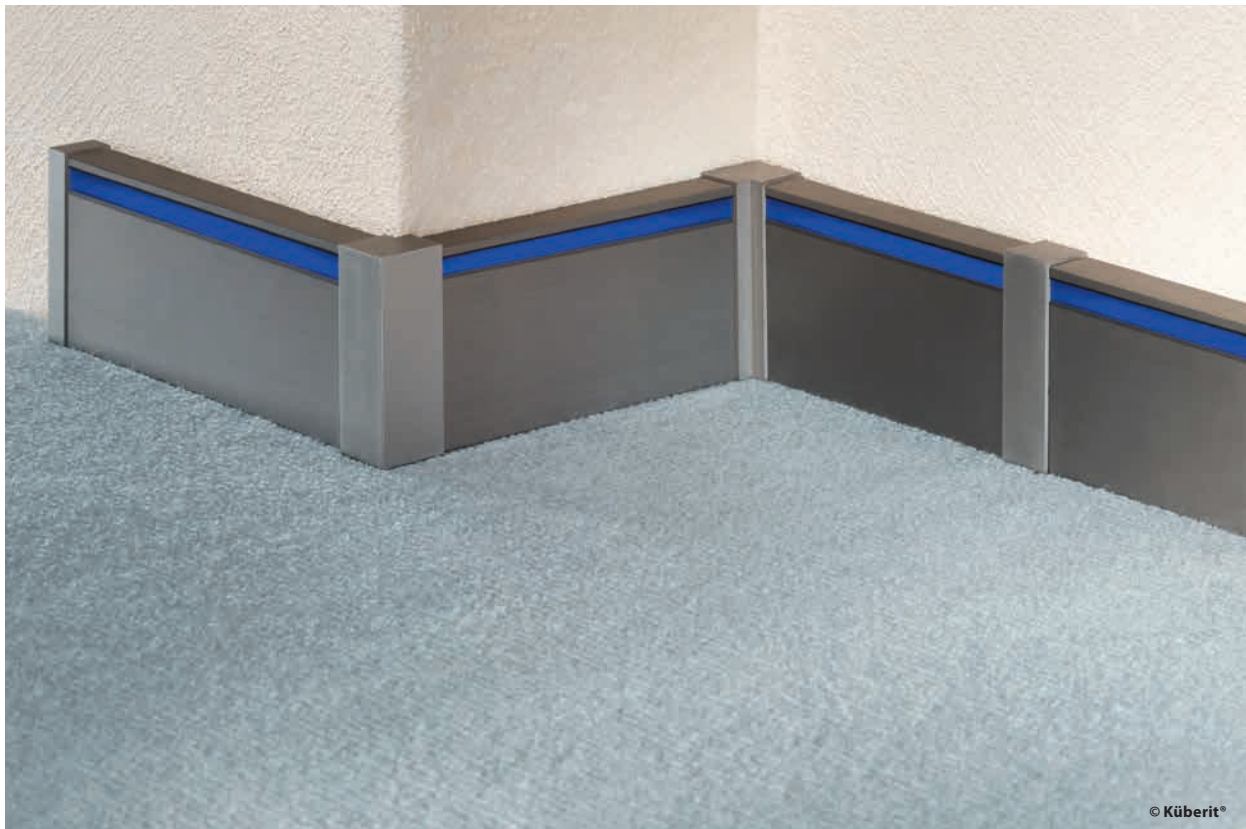

© Küberit®



© Küberit®

Lieferbar in Aluminium eloxiert silber und edelstahl-optisch mit fein geschliffener Oberfläche.
Available in aluminium anodized silver and stainless steel optic with sensitive grinded surface.

936

Endstücke, Ecken und
Verbinder sind
für den Typ **936**
lieferbar.

Caps, corners
and the connector
are available for the
type **936**.

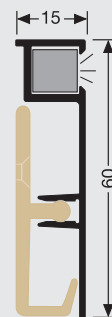

Lieferbare Länge:
available length:
2,5 m

Schrumpfverpackt, mit 7
Wandhaltern, Schrauben & Dübeln
shrink packed, with 7 wall holders,
screws and dowels

ENDSTÜCKE, ECKEN UND VERBINDER · END CAPS, CORNERS AND CONNECTOR



Endstück, links
end cap, left



Endstück, rechts
end cap, right



90° Außenecke
90° external corner



90° Innenecke
90° internal corner



135° Außenecke
135° external corner



135° Innenecke
135° internal corner



Verbinder
connector

ZUBEHÖR FÜR LED

ACCESSORIES FOR LED

Zubehör / Accessories

899

LED-Leuchten, dimmbar
LED lights, dimmable

weiß, kalt, trennbar alle 16,7 cm
white, cold, separable each 16,7 cm

22 Watt / 24 Volt

10 m:

1 Rolle inkl. 1,5 m Zuleitung

1 roll incl. 1,5 m power cable

2,5 m + 1,0 m: inkl. Set / incl. set **895 V**

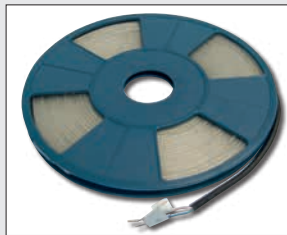

6 LED's pro Teilabschnitt,
360 LED's insgesamt,
pro Rolle 22 Watt
6 LEDs each section,
360 LEDs in total,
22 Watt per roll

895 V

Verbindungsset,
für LED-Leuchten
Connecting set,
for LED lights

Inhalt / Set

1 x 1,5 m Zuleitung
power cable

1 x Längsverbinder
lengthwise-connector

1 x Endkappe / end cap

3 x Schrumpfschlauch
heat shrinkable tubes



895 L

Längsverbinder und
Schrumpfschläuche
für LED-Leuchten
lengthwise-connector and
heat shrinkable tubes
for LED lights



Inhalt / Set

10 x Längsverbinder / 10 x lengthwise-connector

10 x Schrumpfschläuche / 10 x heat shrinkable tubes

894

Rohr
für LED-Leuchten
tube for LED lights



klar / transparent

rot / red

grün / green

blau / blue

2,0 m

898

Diffuser,
für LED-Rohr
diffuser, for LED tube



weiß, für mattes Licht
white, for mat light

10 m Rolle / roll
2,5 m, 1,0 m

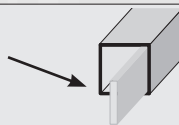

896

LED-Driver,
LED-driver,

für 5 m LED / for 5 m LED

1 x 24 Volt, 12 Watt



inkl. 2 m Zuleitung und Euroflachstecker
incl. 2 m power cable and Euro connector plug

893

LED-Dimmer,
LED-dimmer

24V, max 240W, 10A



897

LED-Driver,
LED-driver,

für 25 m LED / for 25 m LED

1 x 24 Volt, 60 Watt



inkl. 2 m Zuleitung und Euroflachstecker
incl. 2 m power cable and Euro connector plug

ALUMINIUM SYSTEM-SOCKELLEISTE »DECOSTAR«

ALUMINIUM SKIRTING SYSTEM »DECOSTAR«



für 2-11 mm starke Bodenbeläge
for flooring of 2-11 mm thickness



Version mit grauer Dichtlippe!
Version with grey sealing lip!

© Küberit®



© Küberit®

Lieferbar in Aluminium eloxiert silber und edelstahl-optisch mit fein geschliffener Oberfläche.
Available in aluminium anodized silver and stainless steel optic with sensitive grinded surface.

950

950 D

mit 2 Dichtlippen in grau
with 2 sealing lips in grey

Lieferbare Länge:
available length:
2,5 m

Schrumpfverpackt,
inkl. Feder, Schrauben & Dübeln
shrink packed,
incl. Feather, screws and dowels

ENDSTÜCKE, ECKEN UND VERBINDER · END CAPS, CORNERS AND CONNECTOR



Endstück, links
end cap, left



Endstück, rechts
end cap, right



90° Außenecke
90° external corner



90° Innenecke
90° internal corner



Verbinder
connector



ALUMINIUM SYSTEM SOCKELLEISTE 934 UND 934 D

ALUMINIUM SKIRTING SYSTEM 934 AND 934 D



Version mit grauer Dichtlippe!
Version with grey sealing lip!

© Küberit®

934 D

934

Die Endstücke, Ecken und Verbinder sind nur für den **Typ 934 D** mit Dichtlippe lieferbar.

The caps, corners and the connector are only available for the **type 934 D** with sealing lip.

Lieferbare Länge:
available length:
2,5 m

Schrumpferpackt,
mit 7 Wandhaltern, Schrauben &
Dübeln / shrink packed, with 7 wall
holders, screws and dowels

mit 2 Dichtlippen in grau
with 2 sealing lips in grey

ENDSTÜCKE, ECKEN UND VERBINDER FÜR TYP 934 D · END CAPS, CORNERS AND CONNECTOR FOR TYPE 934 D



Endstück, links
end cap, left



Endstück, rechts
end cap, right



90° Außenecke
90° external corner



90° Innenecke
90° internal corner



135° Außenecke
135° external corner



135° Innenecke
135° internal corner



Verbinder
connector

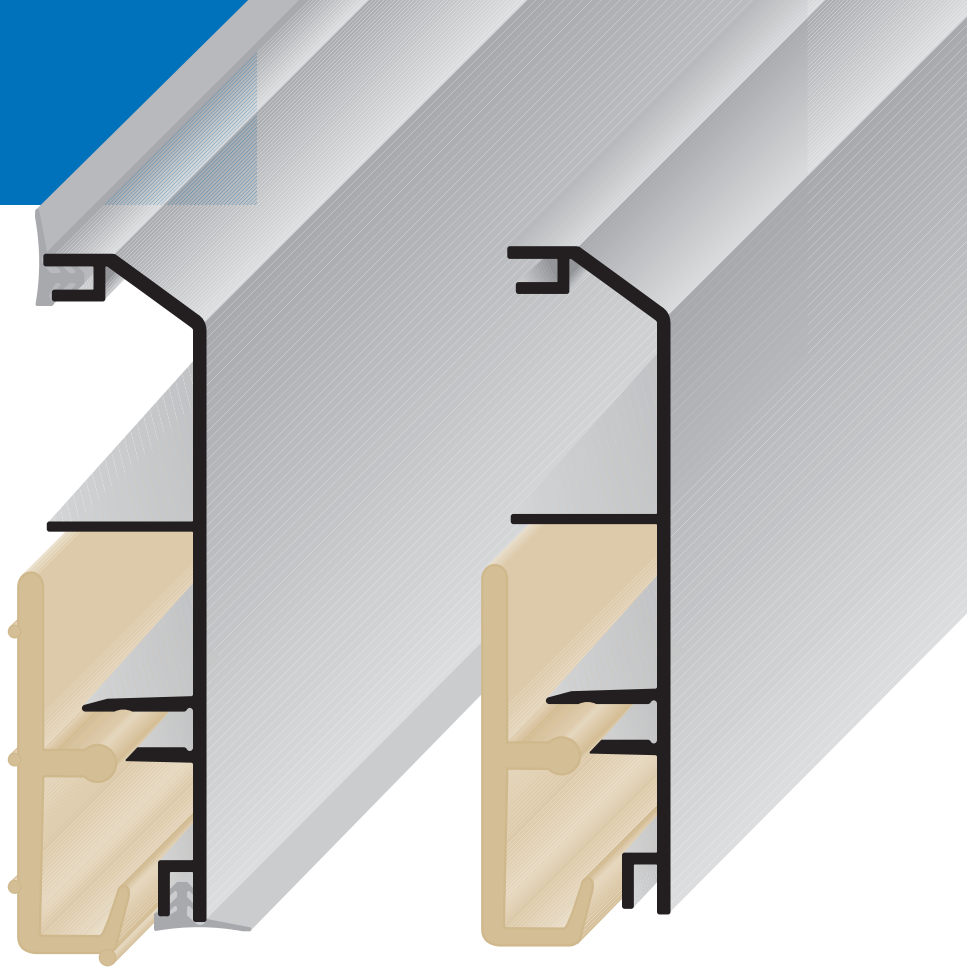

Lieferbar in Aluminium eloxiert silber und edelstahloptik mit fein geschliffener Oberfläche.
Available in aluminium anodized silver and stainless steel optic with sensitive grinded surface.



• für Erker geeignet / suitable for oriels

ALUMINIUM SYSTEM-SOCKELLEISTE · ABGERUNDETES DESIGN

ALUMINIUM SKIRTING SYSTEM · ROUNDED EDGE

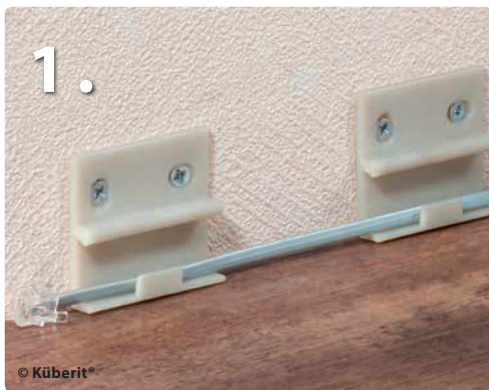
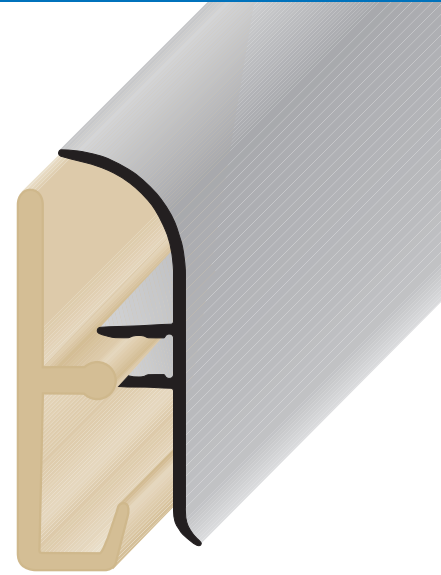
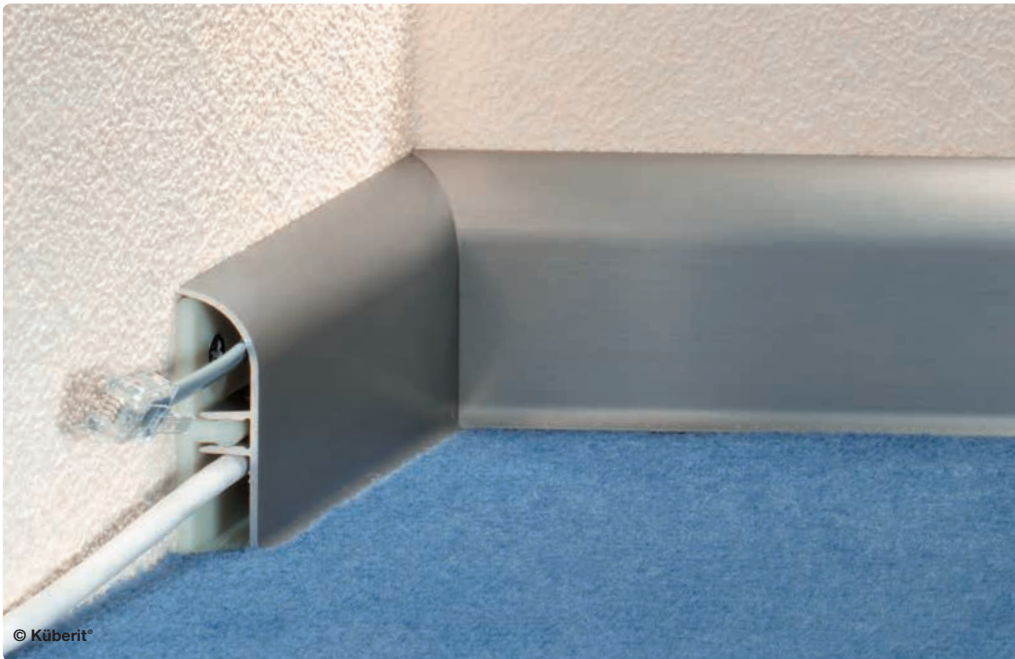

Bei der formschönen **Sockelleiste** lassen sich in den Kabelkanälen Kabel bis zu einem Durchmesser von 10 mm leicht und unsichtbar verlegen. Der hochwertige Wandhalter ermöglicht eine schnelle und einfache Montage auch auf schwierigen Wänden. Auch größere Belastungen stellen für den Wandhalter aus Glasfaser verstärktem Kunststoff keine Herausforderung da.

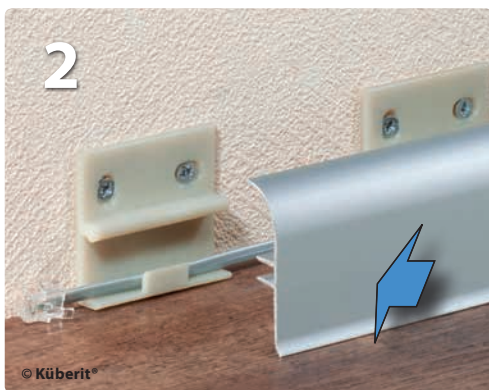

In the shapely **Base-Board** it is possible to place cables up to a diameter of 10 mm easy and invisible in the cable channels. The high-quality wall holder allows a fast and easy assembly also on difficult walls. Also higher mechanic load is no challenge for the wall holder made of plastic reinforced by glass fibre.



Lieferbar in Aluminium eloxiert silber und edelstahloptik mit fein geschliffener Oberfläche.
Available in aluminium anodized silver and stainless steel optic with sensitive grinded surface.



930

GERAUCHSMUSTER
Küberit
UTILITY MODEL

Lieferbare Länge:
available length:
2,5 m

Schrumpfverpackt, mit 7
Wandhaltern, Schrauben & Dübeln
shrink packed, with 7 wall holders,
screws and dowels

ALUMINIUM-SOCKELLEISTE »DECOLINO« FÜR DESIGNBELÄGE

ALUMINIUM SKIRTING »DECOLINO« FOR LVT FLOORINGS



Aluminium-Sockelleiste 945 U, beidseitig einsetzbar,
Ecken, Endstücke und Verbinder aus Aluminium
aluminium skirting 945 U, installable from
both sides, Corners, End caps and Connector made of aluminium

- patentierte Aluminium-Sockelleiste mit bis zu 3 mm Einschub
- beidseitig einsetzbar
- zur Befestigung wird ein hochwertiges Klebeband angeboten

945 U

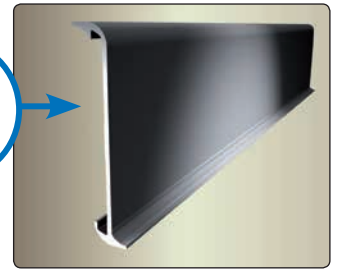
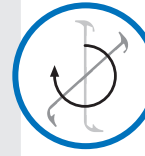
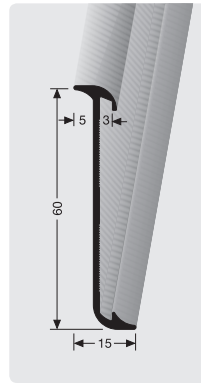

Lieferbare Länge:
available length:
2,5 m

Schrumpfverpackt,
shrink packed

Lieferbar in Aluminium eloxiert silber und edelstahloptik mit fein geschliffener Oberfläche.
Available in aluminium anodized silver and stainless steel optic with sensitive grinded surface.

- patented aluminium skirting board up to 3 mm insertion slot
- can be installed from both sides
- an high-quality adhesive tape for the fixation is available



ENDSTÜCKE, ECKEN UND VERBINDER FÜR »DECOLINO« TYP 945 U¹

END CAPS, CORNERS AND CONNECTOR FOR »DECOLINO« TYP 945 U¹



Endstück, links
end cap, left



Endstück, rechts
end cap, right



90° Außenecke
90° external corner



90° Innenecke
90° internal corner



Verbinder
connector

¹ Aluminium eloxiert silber und edelstahloptik fein geschliffen / aluminium anodized silver and stainless steel optic with sensitive grinded surface



ENDSTÜCKE, ECKEN UND VERBINDER FÜR TYP 912+913²
END CAPS, CORNERS AND CONNECTOR FOR TYP 912+913²



Endstück, links
end cap, left



Endstück, rechts
end cap, right



90° Außenecke
90° external corner



90° Innenecke
90° internal corner



Verbinder
connector

² Kunststoff in silber und edelstahl lackiert (nicht fein geschliffen) / plastic silver and stainless steel lacquered (not fine grinded)

ALUMINIUM SOCKELLEISTE · FLACHES DESIGN

ALUMINIUM SKIRTING · FLAT DESIGN

910 U

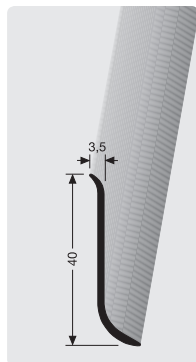

911 U

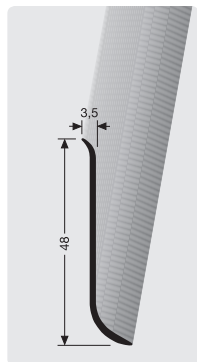

912 U

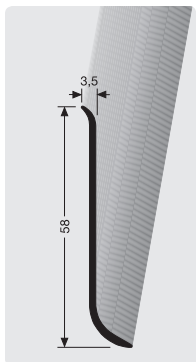

913 U

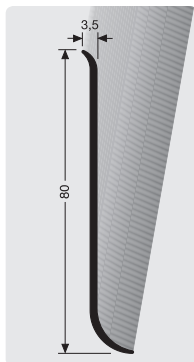

Lieferbare Länge:

available length:

2,5 m

Schrumpfverpackt,
shrink packed,

biegbar / bendable
(max.: Ø=50 cm)

Die Verbinder, Ecken und Endstücke aus Kunststoff für Typ 912U/SK+913U/SK sind paarweise lieferbar in silber und edelstahl lackiert.

The connectors, corners and end caps made of plastic for type 912U/SK+913U/SK are available pairwise in silver and stainless steel lacquered.

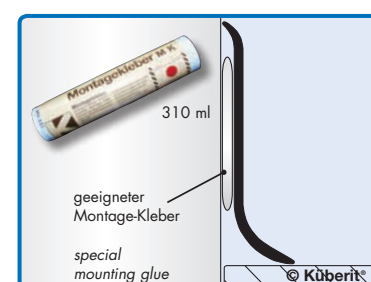

Die ungebohrten **Sockelleisten** werden mit einem geeigneten Montagekleber optimal befestigt. Die selbstklebenden **Sockelleisten** lassen sich ganz leicht verlegen: zuschneiden, Schutzfolie abziehen, andrücken, fertig! Auf Wunsch sind auch Abstandhalter lieferbar, die eine Kabelverlegung bis 8 mm Durchmesser ermöglichen.

The undrilled **Base-Boards** will be should be optimally installed with a special glue. The self-adhesive **Base-Boards** are easy to install: cut, pull off protection foil, press on, finished! By request also distance pieces are available, that allow the installation of cables up to 8 mm in diameter.

910 SK

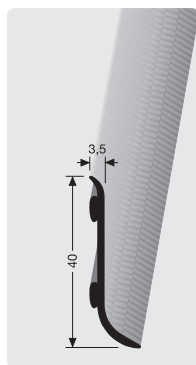

911 SK

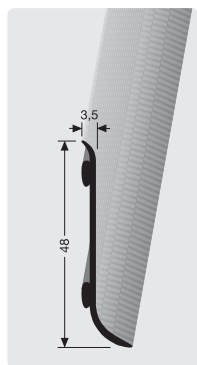

912 SK

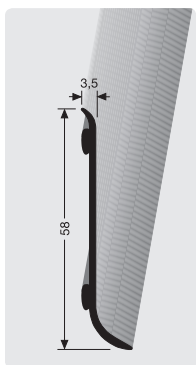

913 SK

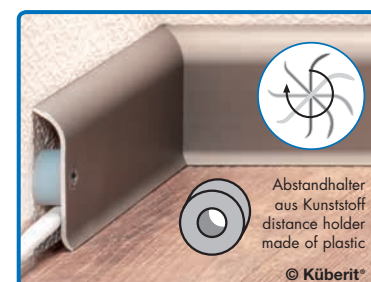
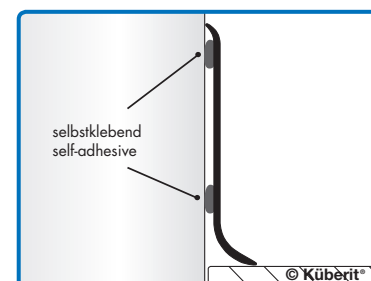

Lieferbar in Aluminium poliert, eloxiert silber, gold, bronze, sand und edelstahl mit fein geschliffener Oberfläche. Typ 913 nur in silber und edelstahl mit fein geschliffener Oberfläche.

Available in aluminium polished, anodized silver, gold, bronze, sand and stainless steel with sensitive grinded surface. Type 913 only in silver and stainless steel with sensitive grinded surface.

MATT GEBÜRSTETE EDELSTAHL SOCKELLEISTE · FLACHES DESIGN

MAT BRUSHED STAINLESS STEEL SKIRTINGS · FLAT DESIGN

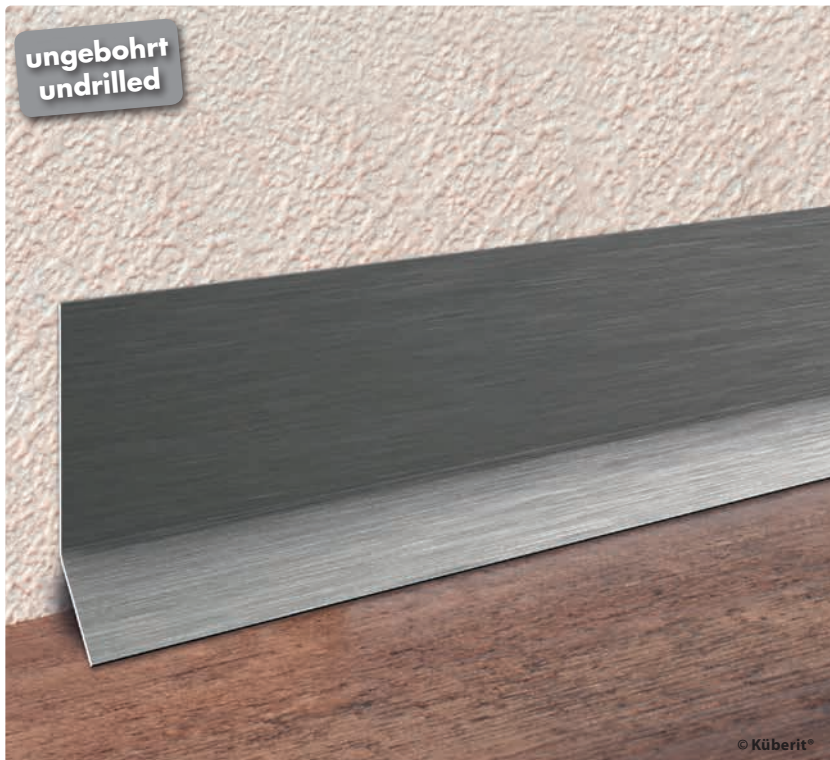

Lieferbar in Edelstahl matt gebürstet.
Available in stainless steel mat brushed.

915 U

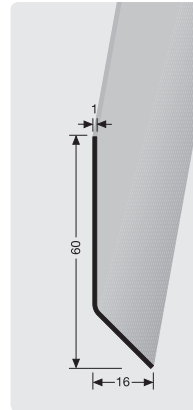

916 U



Lieferbare Länge:
available length:
2,5 m

ALUMINIUM WANDABSCHLUSSPROFIL 369

ALUMINIUM WALL BORDER PROFILE 369



Lieferbar in Aluminium poliert, eloxiert silber, gold, bronze, sand und edelstahloptik sowie weiß pulverbeschichtet. 369 H/SK mit Holzdekor.
Available in aluminium polished, anodized silver, gold, bronze, sand and stainless steel optic as well as powder-coated white. 369 H/SK with wood decor.

369 SK

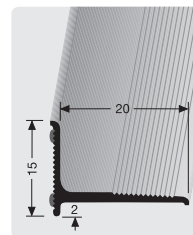

369 H/SK

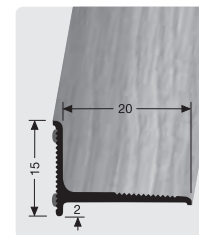

369 N/SK

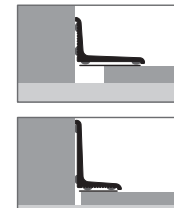
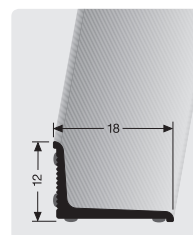

Lieferbare Länge:
available length:
2,7 m

ALUMINIUM TEPPICH-ABSCHLUSSPROFIL 901

ALUMINIUM CARPET BASE-BOARD 901



Lieferbar in Aluminium poliert, eloxiert silber, gold, bronze, sand und edelstahl mit fein geschliffener Oberfläche.

Available in aluminium polished, anodized silver, gold, bronze, sand and stainless steel with sensitive grinded surface.

901

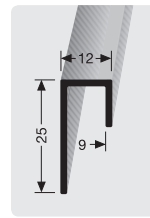

Lieferbare Länge:
available length:

2,5 m / 5,0 m

versenkt gebohrt
countersunk drilled

Schrumpfverpackt,
shrink packed

biegbar / bendable
(max.: Ø=50 cm)

Sockelleiste in
gewünschter Höhe an der Wand
verschrauben, textilen Belag
zuschneiden und einschieben.

Screw the **Base-Board** in the
requested height, cut the textile
covering and slide in.



ALUMINIUM SOCKELLEISTE 920 U

ALUMINIUM SKIRTINGS 920 U



Lieferbar in Aluminium poliert, eloxiert silber, gold, bronze, sand und edelstahl mit fein geschliffener Oberfläche.

Available in aluminium polished, anodized silver, gold, bronze, sand and stainless steel optic with sensitive grinded surface.

920 U

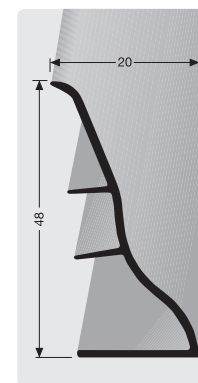

Lieferbare Länge:
available length:

2,5 m

Schrumpfverpackt,
shrink packed

Die spezielle **Sockelleiste** für besonders dicke
Kabel oder große Dehnungsfugen.

The special **Base-Board** for thick cables or
big expansion joints.

TÜRSTOPPER AUS MASSIVEM MESSING

SOLID DOOR STOPPER MADE OF BRASS

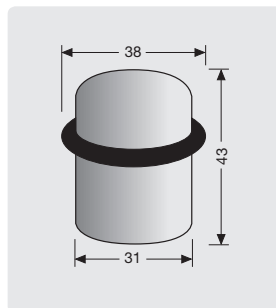

Silber-Optik · silver optics
Messing glanz vernickelt · brass nickel-plated brilliant



Gold-Optik · gold optics
Messing poliert · brass polished



Edelstahl-Optik · stainless steel optics
Messing matt vernickelt · brass nickel-plated mat

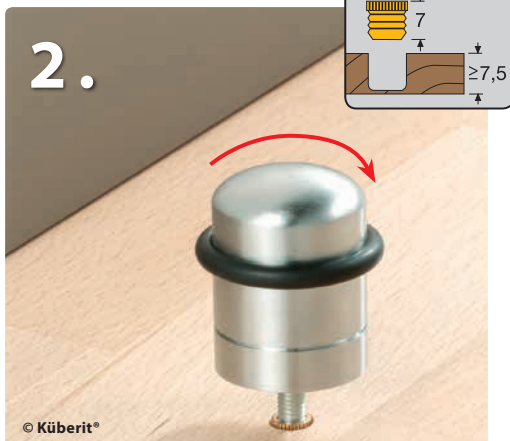

Ganz einfach zu verlegen:

Im Bodenbelag ab 7,5 mm ein Loch bohren (Ø = 8 mm), Metalldübel mit dem Hammer leicht einschlagen und Türstopper darauf verschrauben. Fertig! Das **Dübelssystem** beschädigt nicht den Estrich und ist deshalb ideal für **Fußbodenheizung oder schwimmende Verlegung geeignet**. Zusätzlich geliefert mit Stockschraube und Dübel für Estrich, Fliesen- und Natursteinböden.

Easy to install:

In case of floor coverings of more than 7,5 mm thickness drill a hole (Ø=8 mm), fix the metal dowel slightly with a hammer and screw the door stopper. Finished! The **dowel system** does not cause any damages on the concrete and is suitable for underfloor heating or **for floating floors**. Delivered additionally with hanger bolt and dowel for fixing on concrete, floors with ceramic tiles or natural stones.

ALUMINIUM HEIZROHRROSETTE

ALUMINIUM PIPE FERRULES

leichte & zeitsparende Verlegung!
easy & timesaving installation!

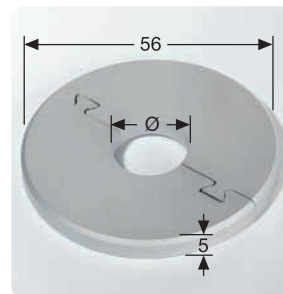

Ø = 12 mm / ZR12
Ø = 15 mm / ZR15
Ø = 18 mm / ZR18
Ø = 22 mm / ZR22

Lieferbar in Aluminium eloxiert silber und
edelstahloptik mit fein geschliffener Oberfläche.
Available in aluminium anodized silver and
stainless steel optic with sensitive grinded surface.

Küberit®
since 1863

PROFILE FÜR IHREN BODEN
Profiles for your floor

optimal kombinierbar mit PPS®-Magic · optimally combinable with PPS®-Magic



Außerordentliches Mitglied im



Muster, drehbar
display, swivelling

Küberit®
since 1863

PROFILE FÜR IHREN BODEN
Profiles for your floor

Küberit Profile Systems GmbH & Co. KG
Römerweg 9 · 58513 Lüdenscheid · Germany
Postfach 81 33 · 58489 Lüdenscheid · Germany

Tel.: +49 (0) 23 51 / 95 07 - 0

Fax: +49 (0) 23 51 / 95 07 - 49

Fax Export: +49 (0) 23 51 / 95 07 - 200

Internet: www.kueberit.com

E-Mail: kueberit@kueberit.com · export@kueberit.com

Ihr Küberit-Fachhändler / Your Küberit-retailer: